

# XDC-6000B

Digital Cinema Xenon Lamp

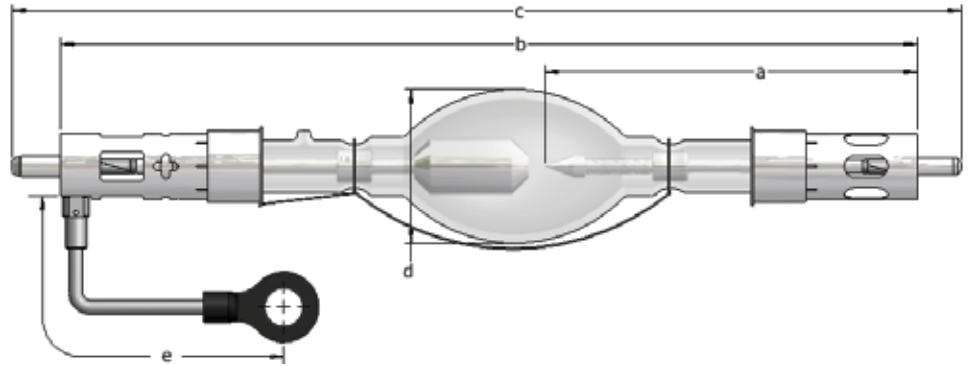

## APPLICATIONS

Barco DP2K-32B, DP4K-32B, DP-90, DP-100, DP-3000

## TECHNICAL SPECIFICATIONS

Rated Power	W	6000
Rated Current	A	157
Operating Current Range	A	140-175
Rated Voltage	V	38
Distance a	mm	170
Length b	mm	391
Length c (max)	mm	433
Cold arc gap	mm	7.5
Bulb Diameter d	mm	70
Anode (+) Base Diameter	mm	30
Anode Pin Diameter	mm	9.4
Cathode (-) Base Diameter	mm	30
Cathode Pin Diameter	mm	7.9
Cable Length e	mm	153
Horizontal Operating Position	deg	±15
Min. Cooling Air Flow Velocity	m/sec	7
Base Surface Temperature (max)	deg C	200

WARRANTY: 600 hours (100%)



Lighting Technologies International LLC  
13700 Live Oak Avenue, Baldwin Park, CA,  
USA 91706  
www.ltilighting.com

Rev. 3 / 2020  
Subject to Change