

# XDC-4002N

Digital Cinema Xenon Lamp

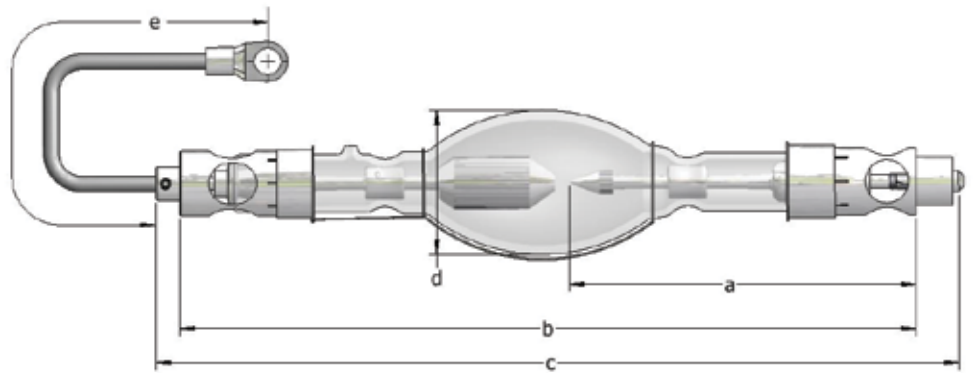

## APPLICATIONS

NEC

NC1600C, NC2000C

## TECHNICAL SPECIFICATIONS

Rated Power	W	4000
Rated Current	A	120
Operating Current Range	A	95-125
Rated Voltage	V	33
Distance a	mm	144
Length b	mm	306
Length c (max)	mm	336
Cold arc gap	mm	6.1
Bulb Diameter d	mm	60
Anode (+) Base Diameter	mm	27
Anode Pin Diameter	mm	14
Cathode (-) Base Diameter	mm	28
Cathode Pin Diameter	mm	20
Cable Length e	mm	160
Horizontal Operating Position	deg	±15
Min. Cooling Air Flow Velocity	m/sec	7
Base Surface Temperature (max)	deg C	200

WARRANTY: 1000 hours (100%)

