

XDC-1800C

Digital Cinema Xenon Lamp

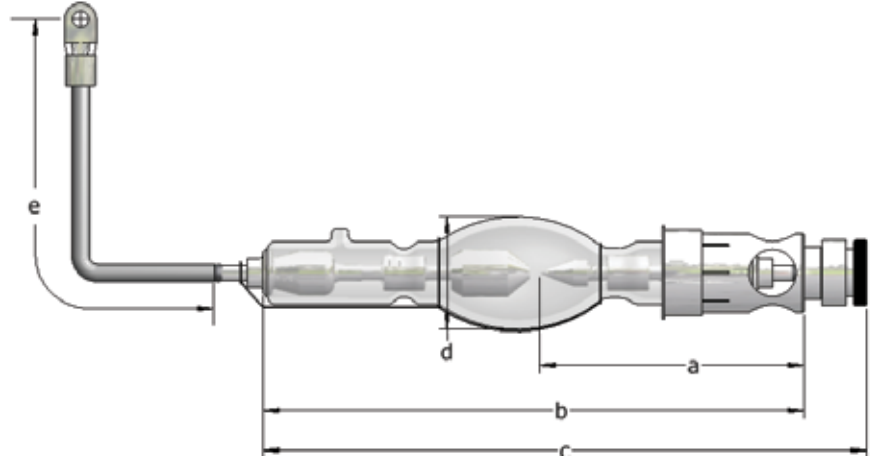

APPLICATIONS

Christie CP2210, CP2215, CP2000-M

TECHNICAL SPECIFICATIONS

Rated Power	W	1800
Rated Current	A	63
Operating Current Range	A	40-75
Rated Voltage	V	28
Distance a	mm	100.5
Length b	mm	221
Length c (max)	mm	243
Cold arc gap	mm	4.1
Bulb Diameter d	mm	43
Anode (+) Base Diameter	mm	N/A
Anode Pin Diameter	mm	N/A
Cathode (-) Base Diameter	mm	30
Cathode Thread Type		M10 x 1.5
Cable Length e	mm	147.5
Horizontal Operating Position	deg	± 15
Min. Cooling Air Flow Velocity	m/sec	7
Base Surface Temperature (max)	deg C	200

WARRANTY: 1750 hours (100%)

